

# Tecniche di computazione quantistica con ioni, atomi e molecole

## Concetti di base e tecniche sperimentali

- Considerazioni generali; proposta di Cirac e Zoller
- La trappola di Paul: cenni storici e modo di operazione
- Manipolazione di ioni nella trappola
- Raffreddamento laser di ioni
- NRM
- Reticoli ottici

# Cenni storici: la trappola di Paul



**W. Paul 1958:** trappola dinamica per ioni; usata per riferimenti stabili di frequenza

## The Simple Paul Trap

Edge View

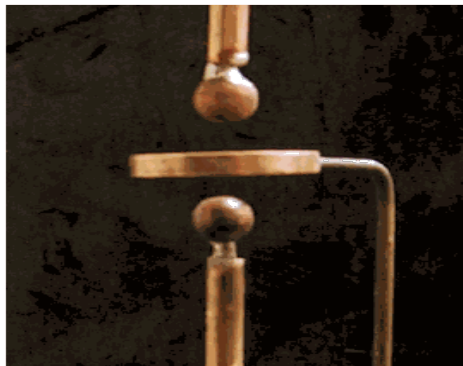

One-Quarter Up

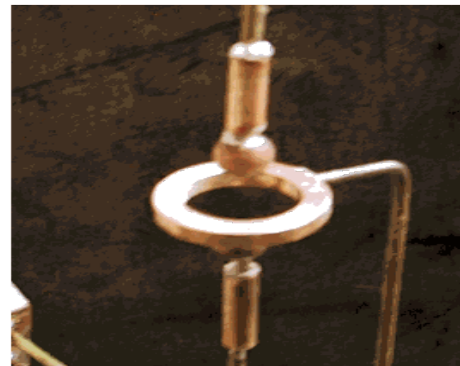

# Ioni intrappolati: *tecniche*

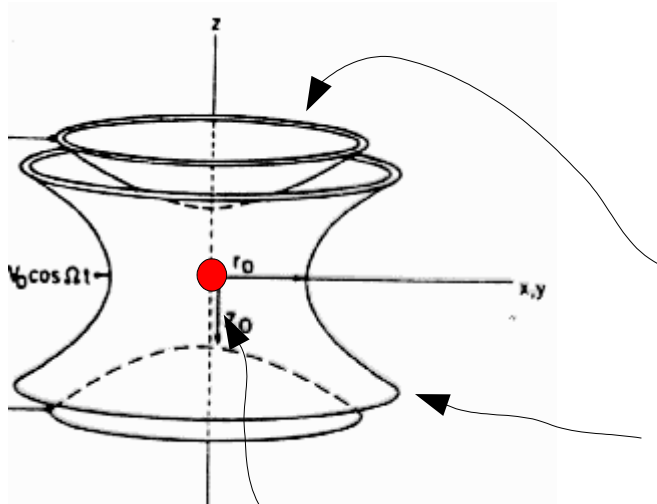

tecnica di base: la trappola di Paul

campi elettrici oscillanti che creano una trappola stabile (“sella ruotante”)

ione intrappolato

trappola di Paul lineare

catena di ioni interagenti tramite repulsione di Coulomb

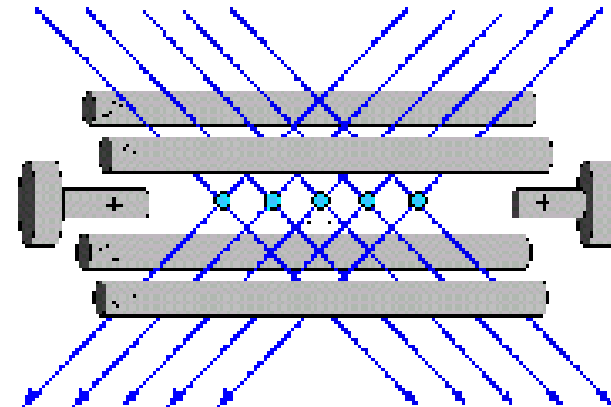

# La «sella ruotante»

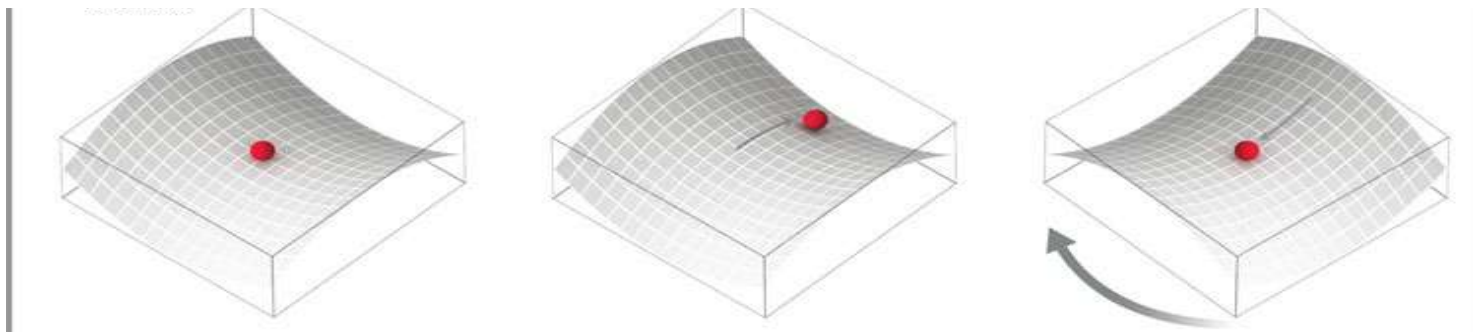

# La trappola di Paul

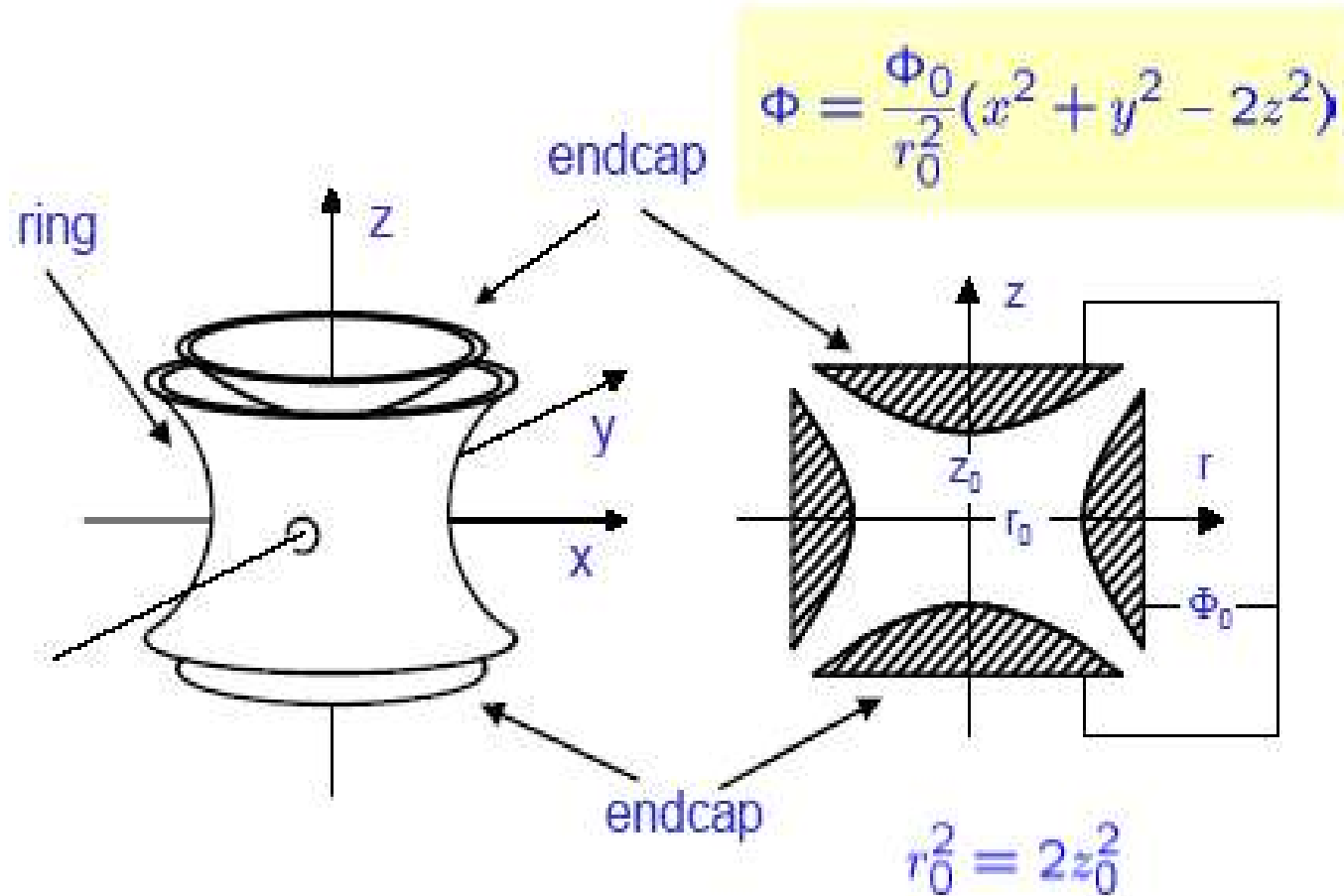

# Le trappole di Paul e Penning

ion confinement requires a focusing force in 3 dimensions:

$\vec{r}$  binding force  $\vec{F} \sim -\vec{r} \Rightarrow \vec{F} = e\vec{E} = -e\nabla\Phi \Rightarrow \Phi \sim \vec{r}^2$

quadrupole potential

$$\Phi = \frac{\Phi_0}{r_0^2}(x^2 + y^2 - 2z^2)$$

Paul trap:  $\Phi_0 = U_0 + V_0 \cos \Omega t$

Penning trap:  $\Phi_0 = U_0 + \text{axial magn. field}$

equation of motion in a Paul trap:

$$\ddot{x} + (a - 2q \cos \Omega t) \frac{\Omega^2}{4} x = 0$$

$a \sim U_0, q \sim V_0$

MATHIEU EQUATION

frequencies of secular motion:

$\omega_x, \omega_y, \omega_z$

superimposed is micromotion with:

$\Omega$

$$\omega \approx (a + \frac{1}{2}q^2)\Omega$$

1D-solution of Mathieu equation

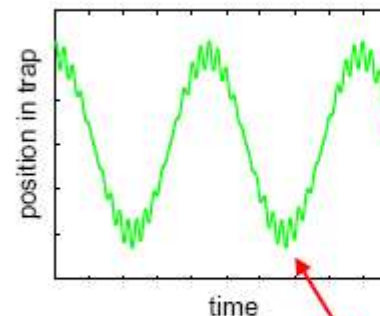

single Al dust particle in trap



Wuerker, Shelton, Langmuir, J. Appl. Phys. **30**, 342 (1959)

micromotion

# La trappola di Paul

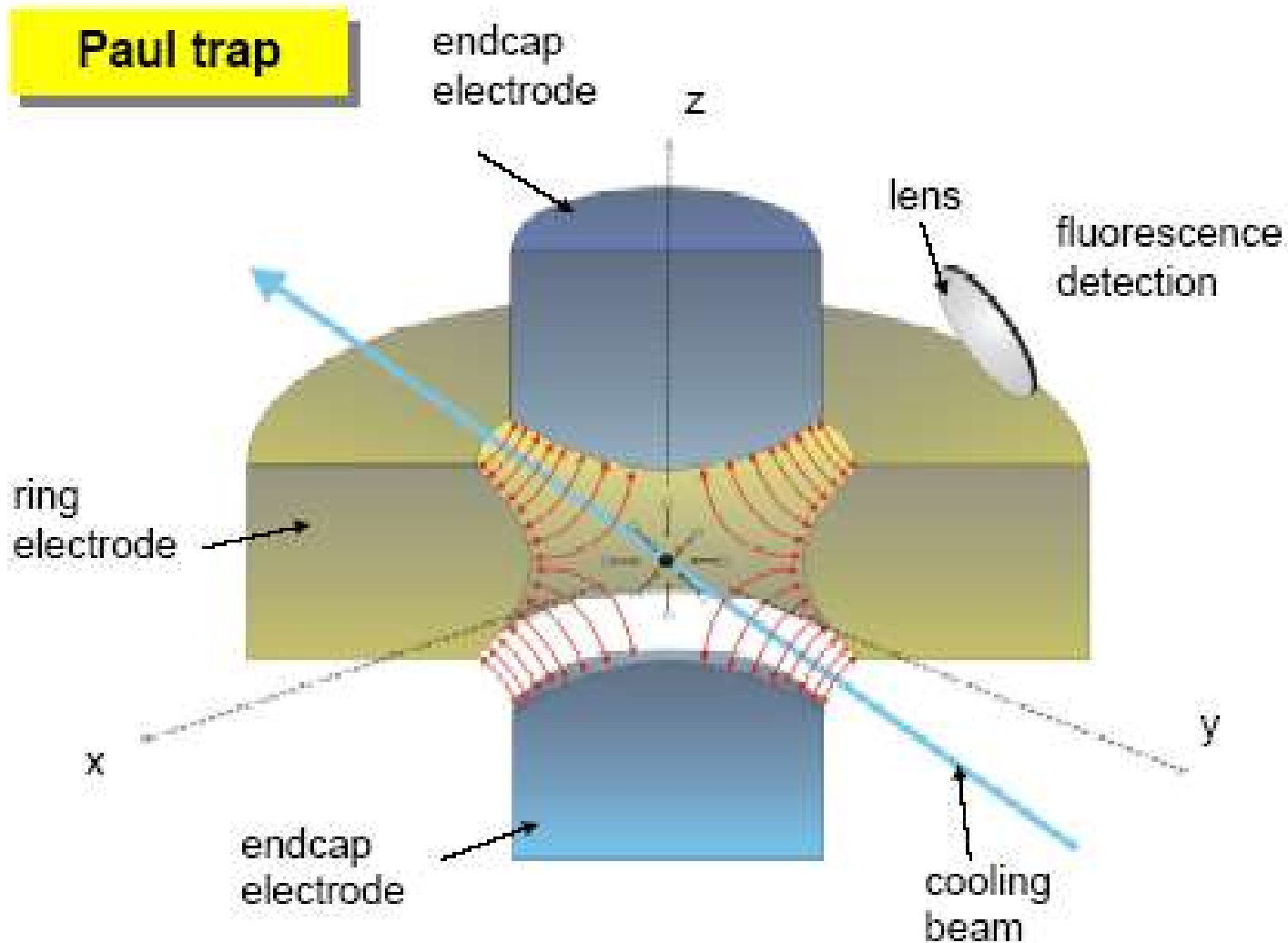

# Trappola di Paul: *parametri tipici*

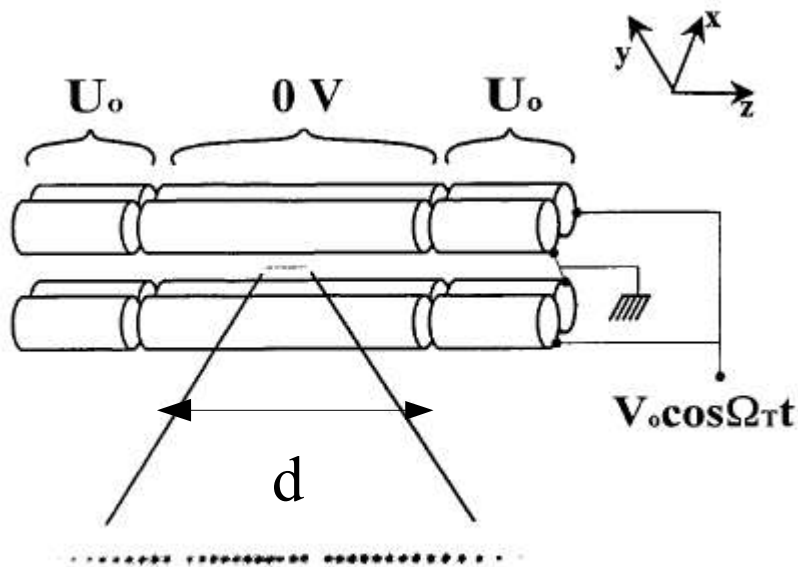

**separazione degli elettrodi:**  
100 micrometri fino a alcuni mm;

**campo r.f.:** 10-300 Mhz;  
 $V_0 \sim 100 \text{ V}$

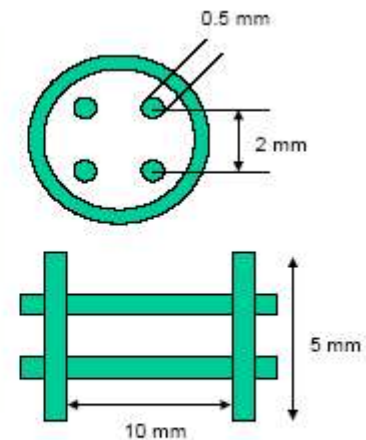
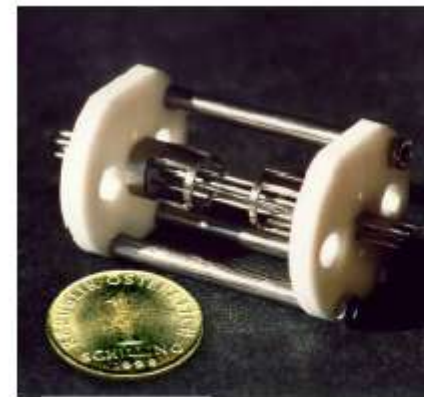

The Quadrupole Electric Field

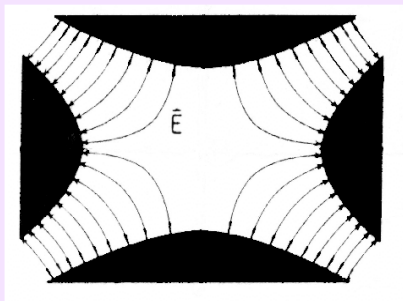

$$\kappa \approx 0.05$$

$$\omega_z \approx 700 \text{ kHz}$$

$$\omega_{x,y} \approx 1.2 - 2 \text{ MHz}$$

**=> frequenza radiale di trappola:**  
da 100 kHz a 10 Mhz;

**separazione tra due ioni:**

1 micrometro fino a 15 micrometri



# Catena di ioni

Coulomb repulsion defines a length scale

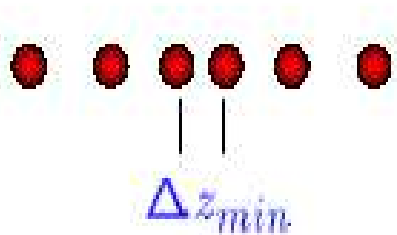

$$z_s = \left( \frac{e^2}{4\pi\epsilon_0 m \omega_z^2} \right)^{1/3}$$

$$\Delta z_{min} \approx 2.0 z_s N^{-0.57}$$

Mode frequencies are nearly independent of ion number  $N$

$$\nu_n = \nu \{1, \sqrt{3}, \sqrt{29/5}, 3.05, 3.67, 4.23, 4.86, 5.44, \dots\}$$

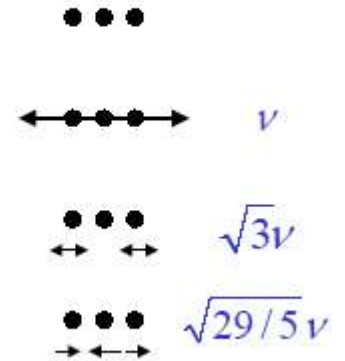
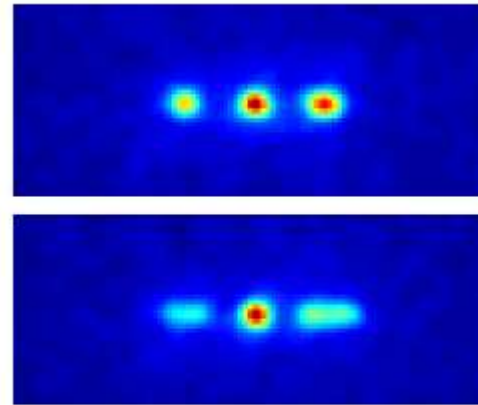

# Moto quantistico degli ioni

$$x_i(t) = C \left( 1 - \frac{q_i}{2} \cos \Omega t \right) \cos \omega_i t, \quad i \in \{x, y, z\}$$

classical ion motion = micromotion + secular motion

secular approximation  $a_i, q_i \ll 1 \rightarrow \omega_i \ll \Omega$

neglects micromotion and interprets motion as generated by „pseudo-potential“

$$e\Psi = \frac{1}{2} \sum_i m\omega_i^2 x_i^2, \quad i \in \{x, y, z\}$$

Thus, we define

$$a_i^\dagger = \sqrt{\frac{m\omega_i}{2\hbar}} x_i + \frac{i}{\sqrt{2m\hbar\omega_i}} p_i \quad a_i = \sqrt{\frac{m\omega_i}{2\hbar}} x_i - \frac{i}{\sqrt{2m\hbar\omega_i}} p_i$$

and obtain the Hamiltonian

$$H = \sum_i \hbar\omega_i \left( a_i^\dagger a_i + \frac{1}{2} \right)$$

# Moto quantistico degli ioni

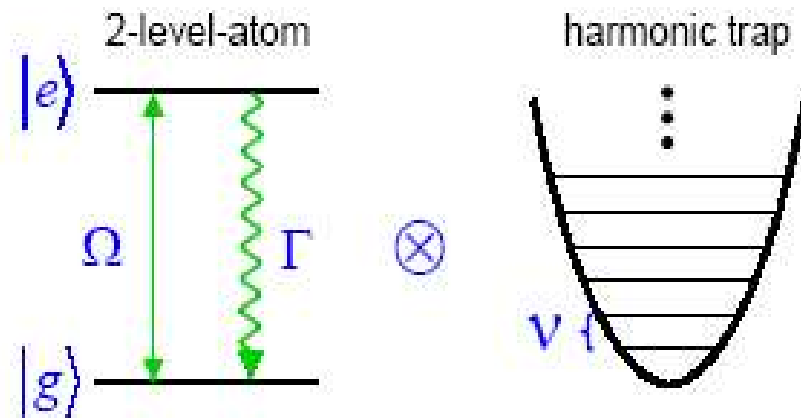

coupled system

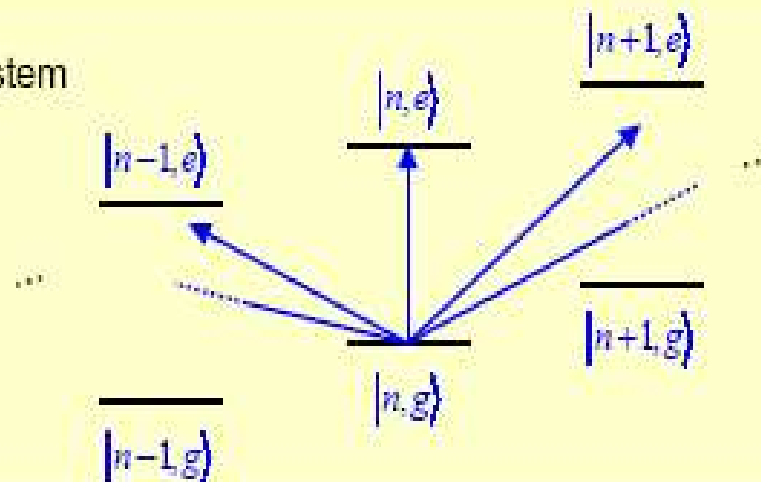

# Raffreddamento laser

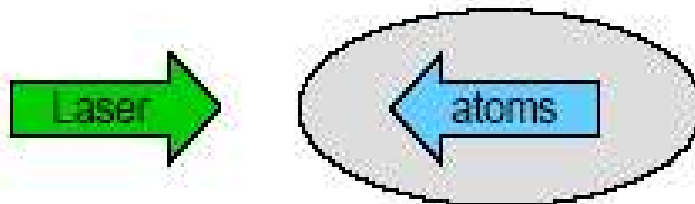

momentum transfer  $\hbar \vec{k}_{abs} - \hbar \vec{k}_{em}$

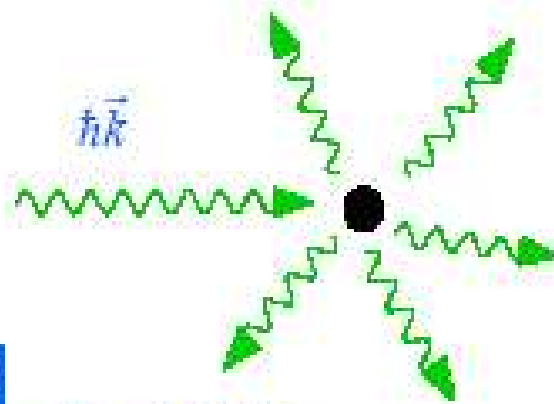

$$\frac{|\hbar \vec{k}|}{m} = \Delta v \approx 1 \text{ cm/s}$$

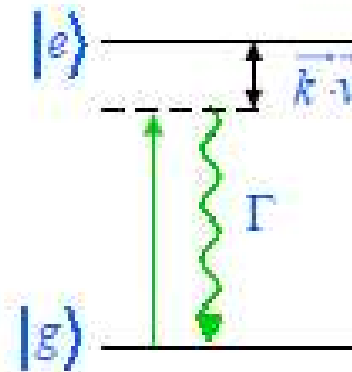

$$\Delta \vec{p} = n \hbar \vec{k}_{abs} + \underbrace{\sum \hbar \vec{k}_{em}}_{=0}$$

$$\Delta \vec{p} = \langle n \rangle \hbar \vec{k}_{abs}$$

Doppler cooling limit:

$$E_D = \hbar \frac{\Gamma}{2}$$

# Raffreddamento laser

## Laser Cooling of Trapped Atoms

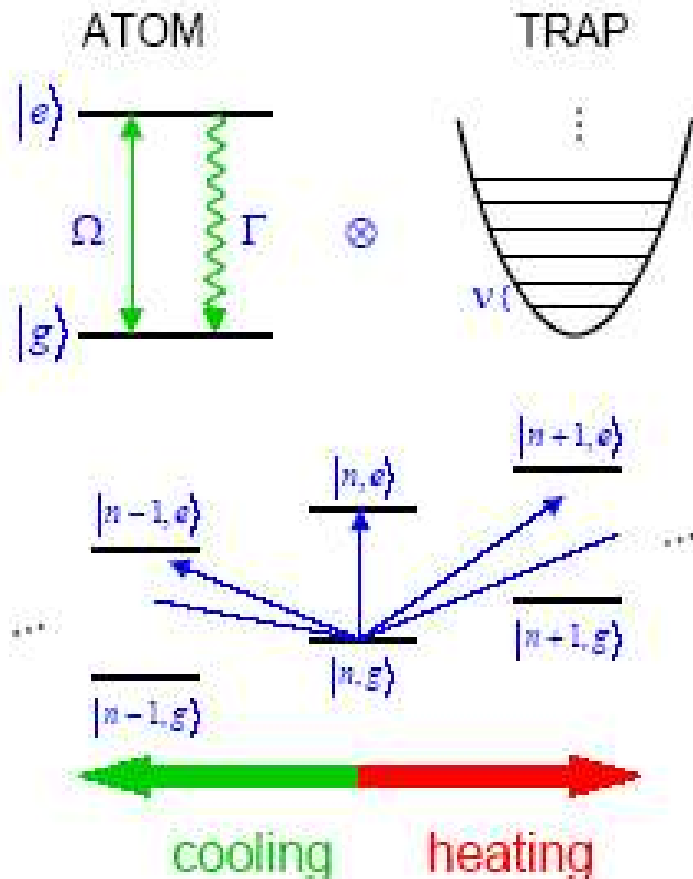

for details see:

- D. Wineland, W. Itano,  
Phys. Rev. A 20, 1521 (1979)
- S. Stenholm,  
Rev. Mod. Phys. 58, 699 (1986)

Regimes:

$\nu < \Gamma$  **weak** confinement,  
Doppler cooling

$$E_D = \hbar\Gamma/2, \langle n \rangle \gg 1$$

$\nu > \Gamma$  **strong** confinement,  
sideband cooling

$$E_S = \hbar\nu(\Gamma^2/4\nu^2 + 1/2)$$

$$\langle n \rangle \ll 1$$

# Raffreddamento laser

## Cooling and heating transitions (Doppler cooling)

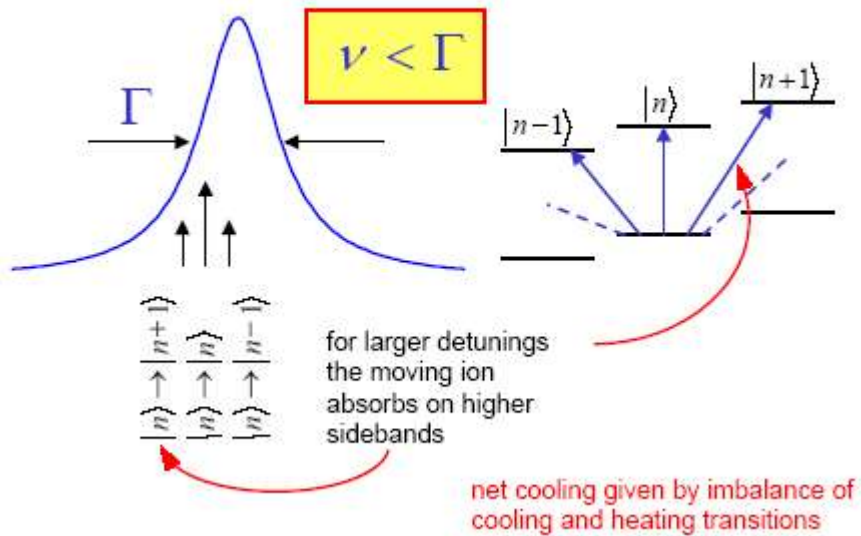

## Cooling and heating transitions (sideband cooling)

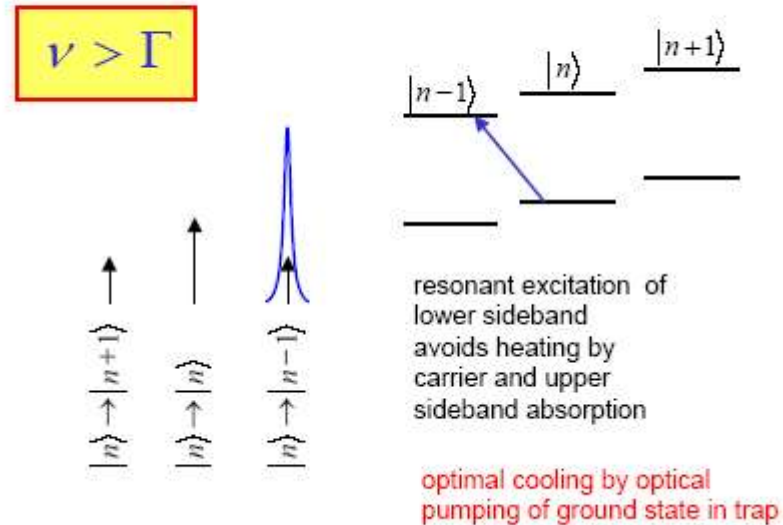

# Ioni intrappolati: *tecniche*

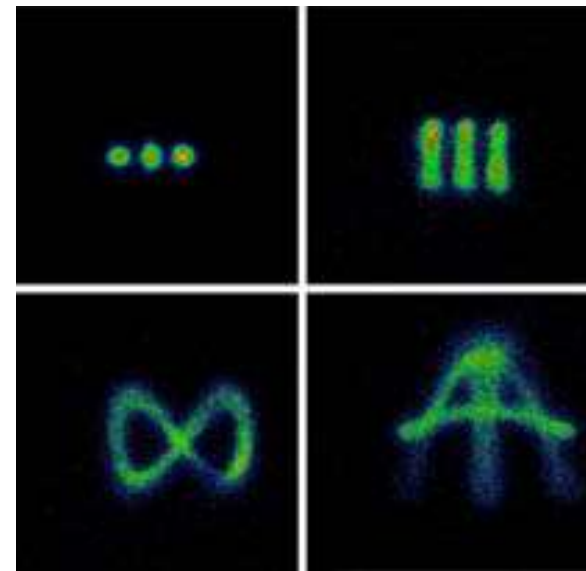
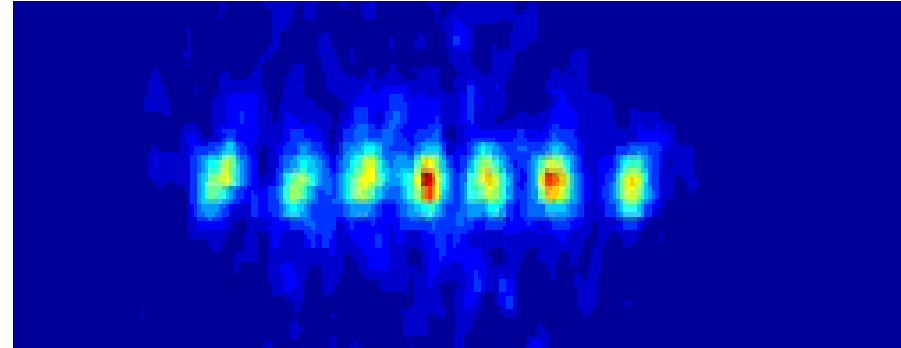
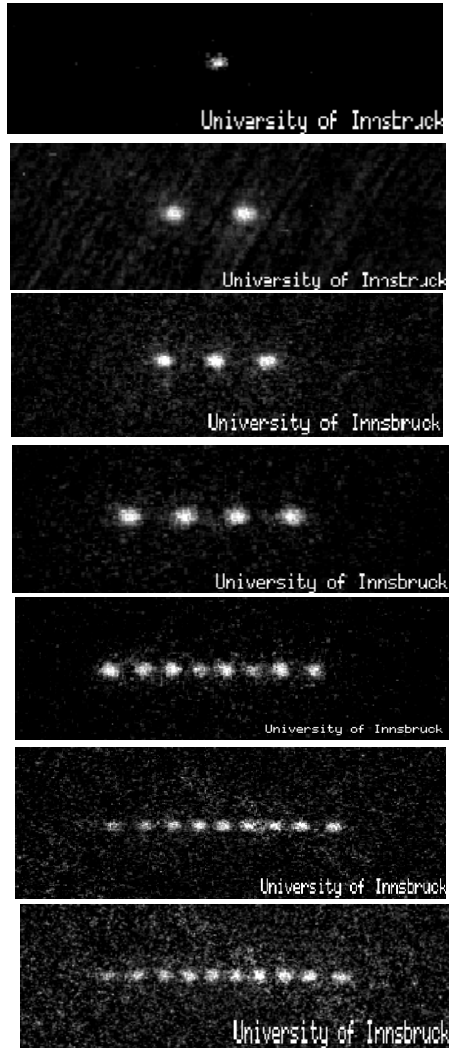

creazione di stati di moto degli ioni -> stati entangled

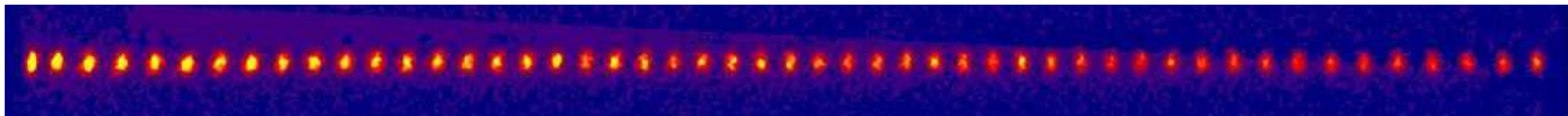

# Ioni intrappolati: *tecniche*

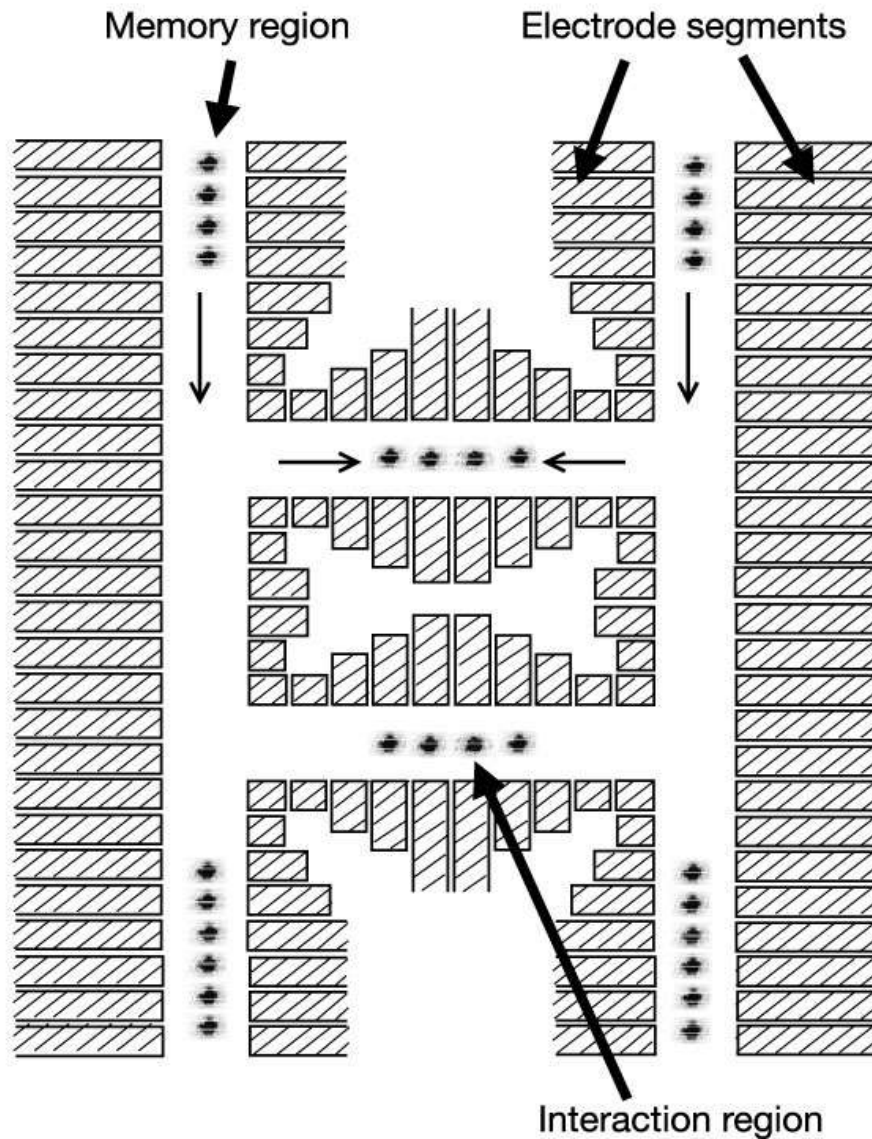

Nature **417**, 709



# I “comandamenti” di DiVincenzo

critereon	physical implementation	technique	
scalable qubits	internal atomic transitions (2-level-systems)	linear traps (trap arrays)	✓
initialization	laser cooling, state preparation	optical pumping, laser pulses	✓
long coherence times	narrow transitions (optical, microwave)	coherence time ~ ms - min	✓
universal quantum gates	single qubit operations, two-qubit operations	Rabi oscillations Cirac-Zoller CNOT	✓
qubit measurement	quantum jump detection	individual ion fluorescence	✓
convert qubits to flying qubits	coupling of ions with high finesse cavity	CQED, bad cavity limit	T E
faithfully transmit flying qubits	coupling of cavities via fiber (photonic channel)	coupling pulse sequences (CZKM)	T E

# Sviluppi recenti

realizzazione di uno stato entangled tra un atomo e un fotone: possibilità di trasmissione di informazione quantistica

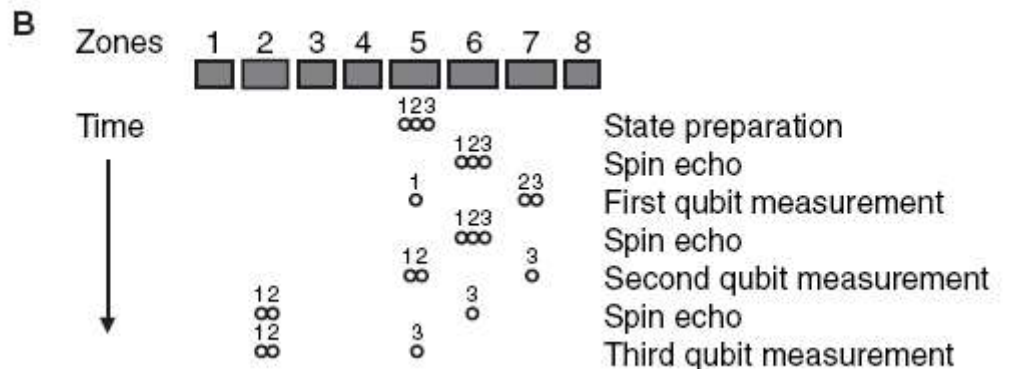
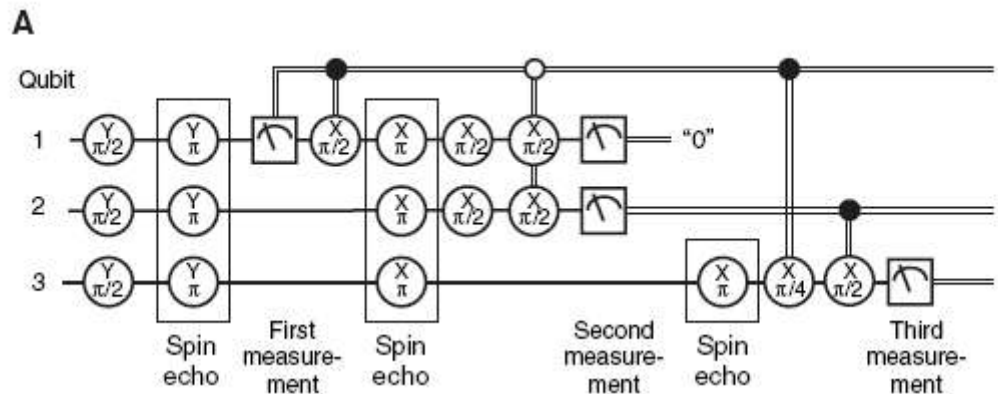
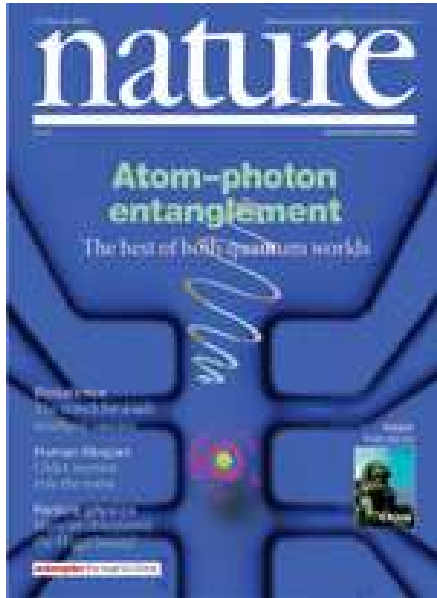

## Implementation of the Semiclassical Quantum Fourier Transform in a Scalable System

J. Chiaverini,\* J. Britton, D. Leibfried, E. Knill, M. D. Barrett,†  
R. B. Blakestad, W. M. Itano, J. D. Jost, C. Langer, R. Ozeri,  
T. Schaetz,‡ D. J. Wineland

# Computer quantistico NMR

con NMR, si può estrarre l'architettura di una molecola



conoscendo l'architettura della molecola, con NMR si può agire in maniera controllata sui suoi spin



agendo sugli spin e sfruttando le loro interazioni, si può inizializzare un registro e si possono applicare dei gates

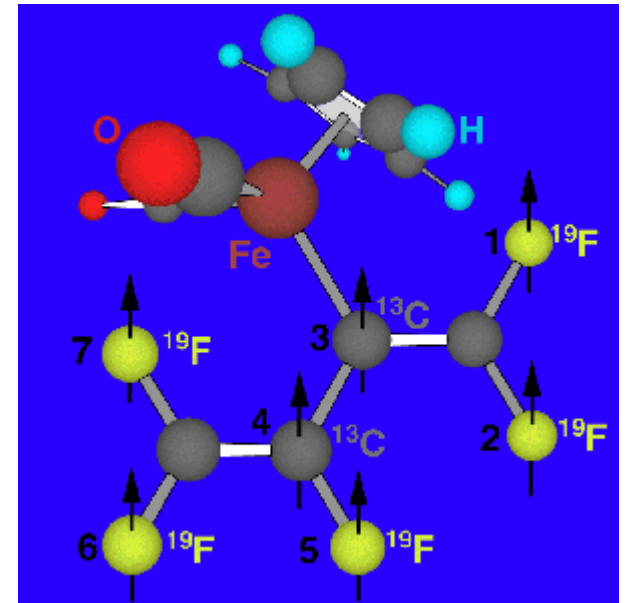

# Computer quantistico NMR

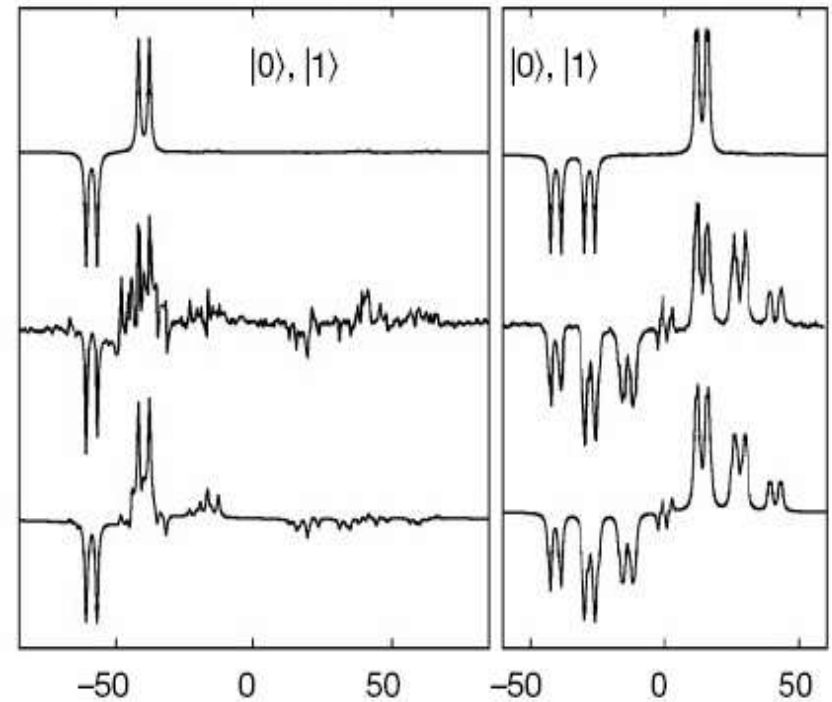
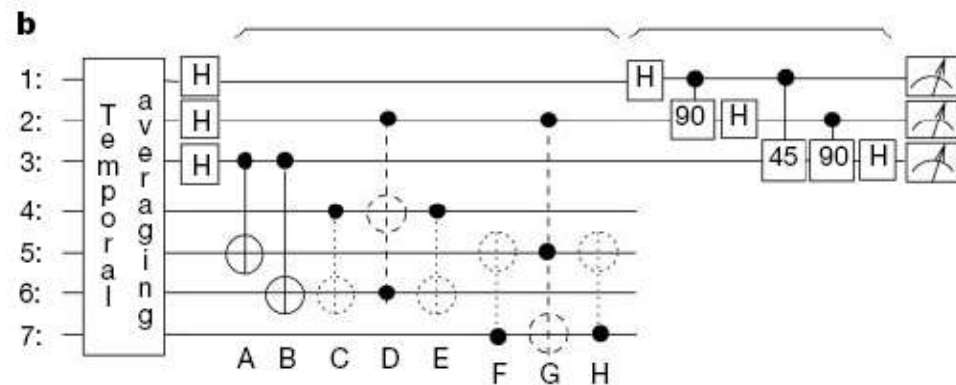
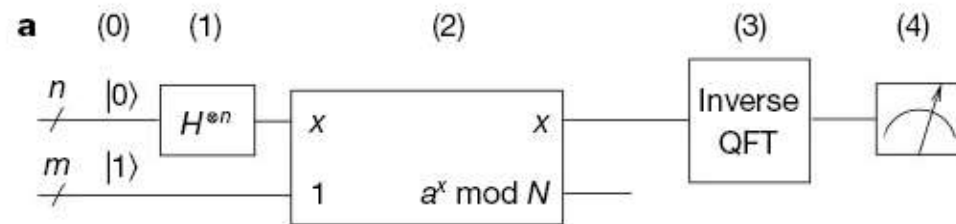

# Atomi neutri in reticoli ottici

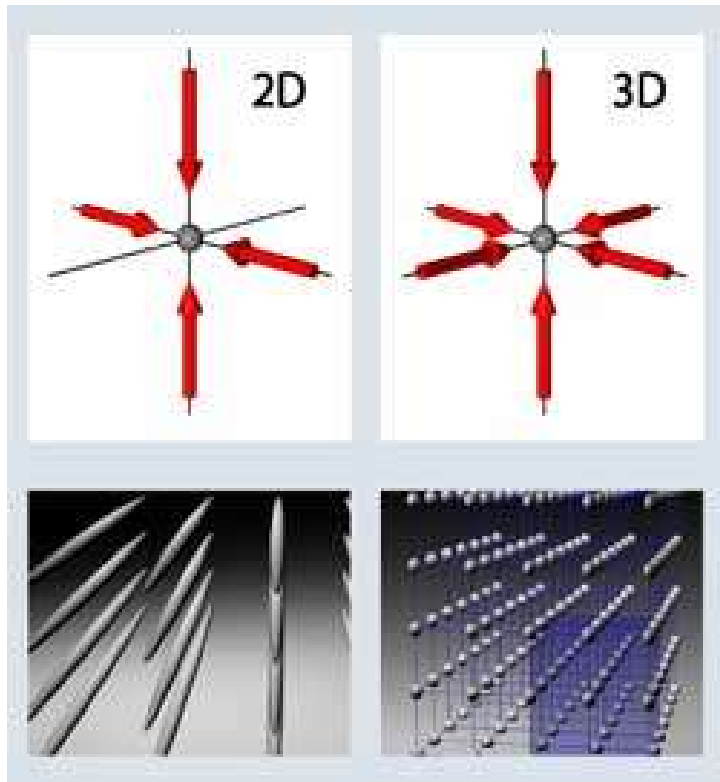

vantaggi:

- controllo eccellente sulla geometria del reticolo
- atomi neutri interagiscono meno con l'ambiente
- sfrutta tecnologie ben studiate

svantaggi:

- difficile accedere a un singolo atomo
- mancanza di un'interazione forte tra gli atomi

fasci laser incrociati creano un “cristallo artificiale” in cui gli atomi vengono intrappolati in delle mini-gabbie

# L'isolante di Mott

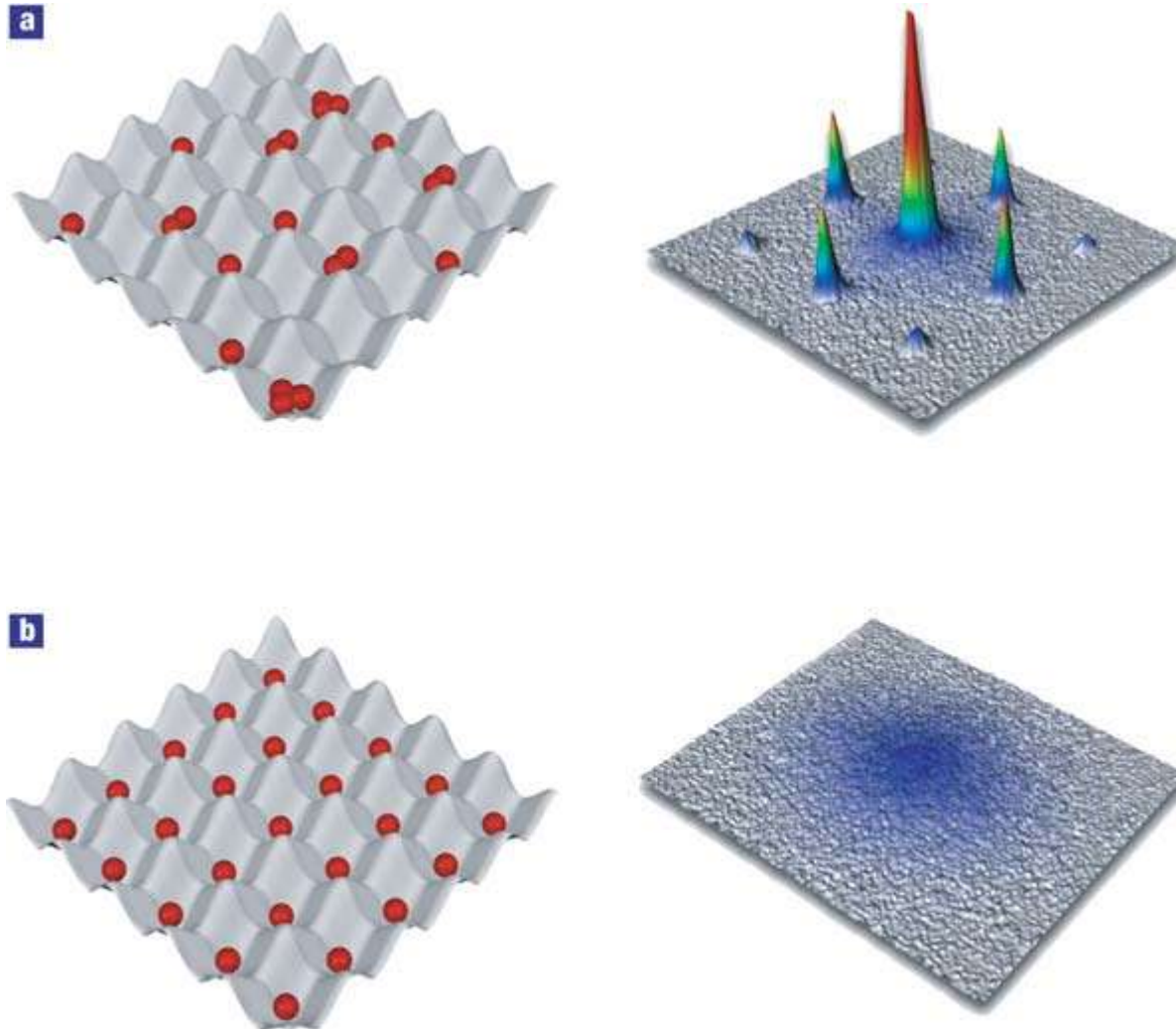

# Atomi neutri in reticoli ottici: *creazione di stati entangled*

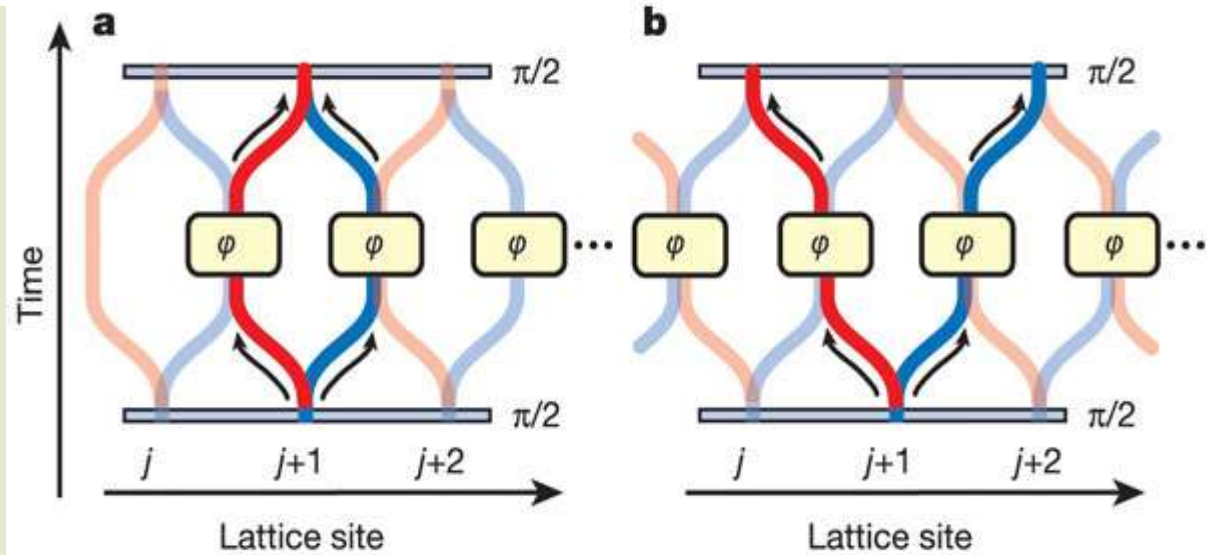
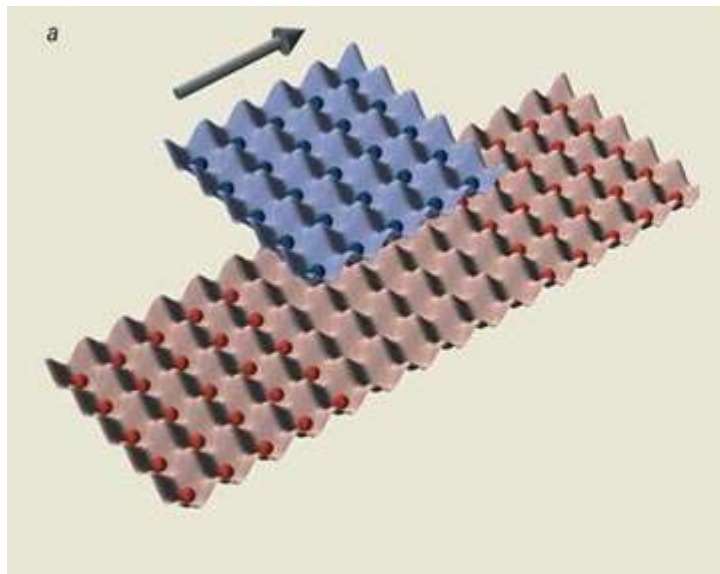

Nature **425**, 937



# Approcci alternativi

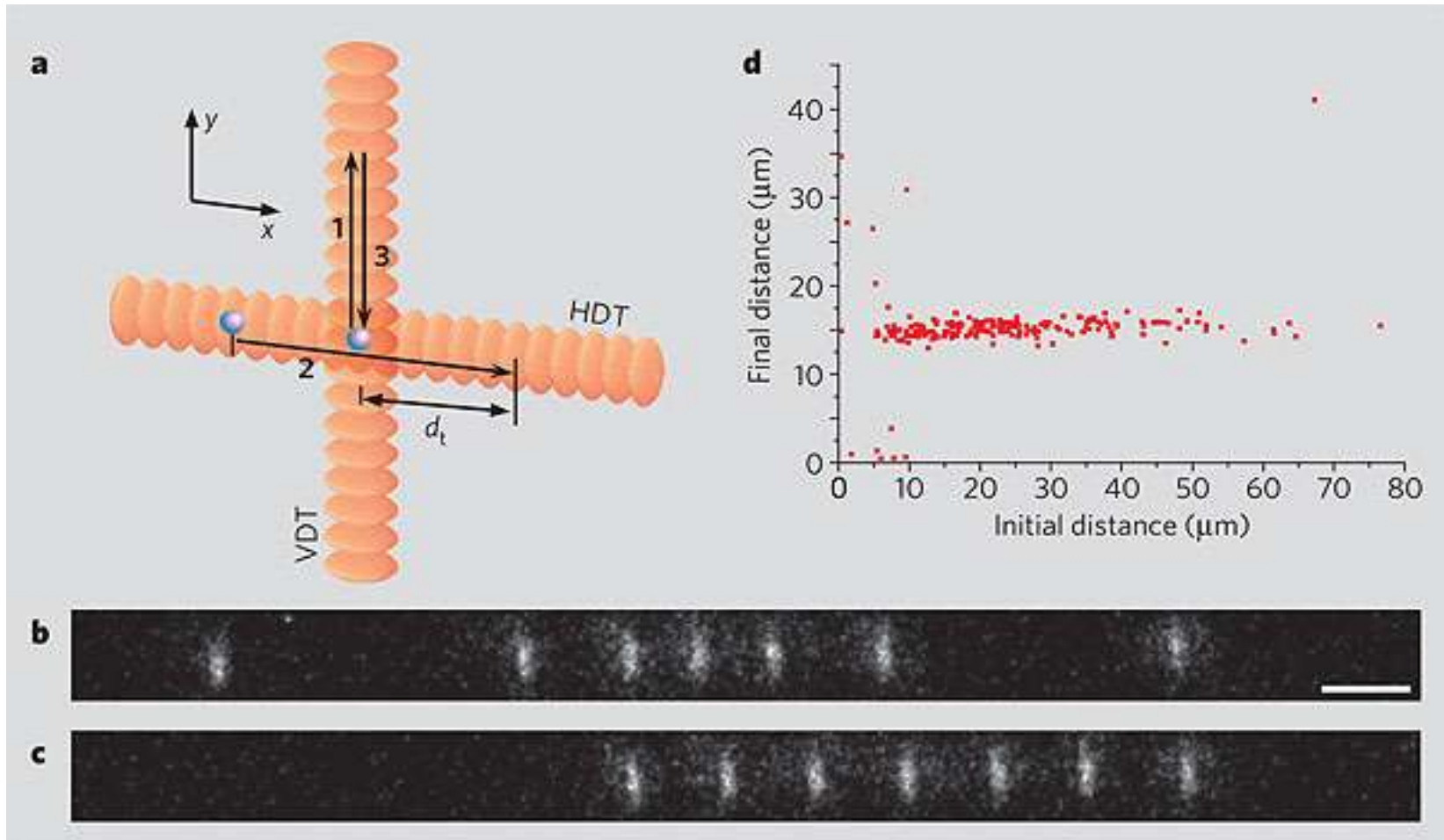



# Esame - argomenti

**Presentazione (ca. 20 min):** Introduzione con riferimento agli argomenti del corso –  
Riassunto del contenuto dell'articolo(i) – Discussione

**Relazione** di circa due-tre pagine che verrà messa sul sito del corso

## Argomenti teorici:

D.E. Brown et al., Nature Physics 19-26 (2009): Measurement-based q.c.

D. Gross et al., Phys. Rev. Lett. 102, 190501 (2009): Ruolo dell'entanglement nella q.c.

## Argomenti sperimentali:

M.T. Rakker et al., Nature 439, 949 (2006): Counterfactual q.c.

K.J. Resch et al., Nature 434, 169 (2005): One-way q.c.

J. O'Brien et al., Science 318, 1567 (2007): Optical q.c.

R. Stock et al., Phys. Rev. Lett. 102, 170501: Q.C. scalabile con ioni

T. Monz et al., Phys. Rev. Lett. 102, 040501 (2009): Toffoli gate con ioni

B.P. Cayan et al., Phys. Rev. Lett. 101, 200501 (2008): Q.C. senza entanglement

Y. Tokumaga et al., Phys. Rev. Lett. 100, 210501 (2008): Generazione di cluster fotonici

S. Vallone et al., Phys. Rev. Lett. 100, 160502 (2008): One-way q.c.

B.P. Lanyon et al., Phys. Rev. Lett. 99, 250505 (2007): Shor

M.S. Tame et al., Phys. Rev. Lett. 98, 140501 (2007): Deutsch on one-way q.c.